



Manway Lid Seals

www.completerubber.com.au

TANK LID SEALS

Product Code: Z176-1

Product Description: Manway Seal MWS1632 White Silicone

NB: Can be made in any other rubber compound to suit customer application.

- Food Grade Non Toxic White Silicone
- Odourless and Tasteless
- Long Lasting – Resistant to Oxidation, UV and Ozone
- Resistant to Mould and Dew
- Resistant to Moderate Chemicals, Fluids and Oils
- Will not rot
- Does not cause staining
- Resistant to Extreme Temperatures -50°C to +200°C
- Does not support Fungoidal Growth, Mould or Bacteria
- Withstands Hot Water and Low Pressure Steam

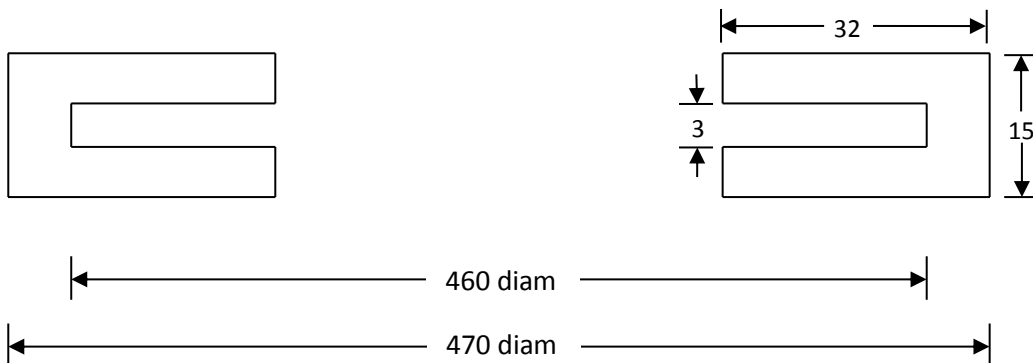

TANK LID SEALS

Product Code: Z180-3

Product Description: Manway Seal MWS1632 White Silicone

NB: Can be made in any other rubber compound to suit customer application.

- Food Grade Non Toxic White Silicone
- Odourless and Tasteless
- Long Lasting – Resistant to Oxidation, UV and Ozone
- Resistant to Mould and Dew
- Resistant to Moderate Chemicals, Fluids and Oils
- Will not rot
- Does not cause staining
- Resistant to Extreme Temperatures -50°C to $+200^{\circ}\text{C}$
- Does not support Fungoidal Growth, Mould or Bacteria
- Withstands Hot Water and Low Pressure Steam

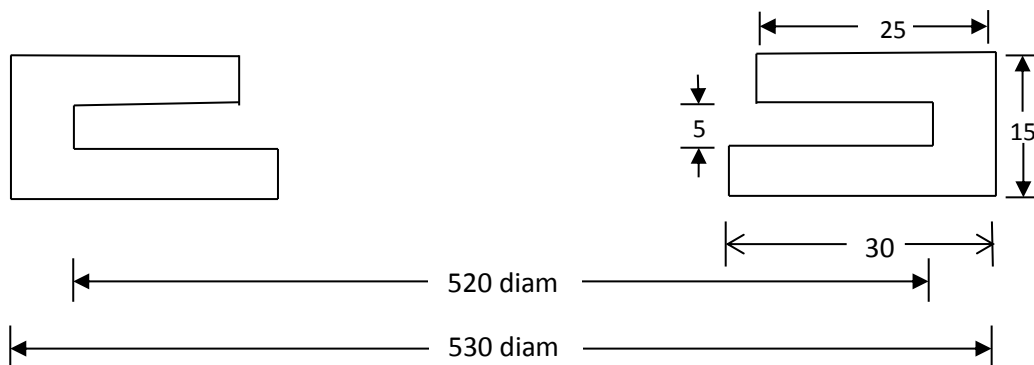

TANK LID SEALS

Product Code: Z184

Product Description: O Ring Type

- White Hygienic Natural Rubber
- Temperature -30°C to +80°C
- 60 Duro Hardness

Other compounds available upon request

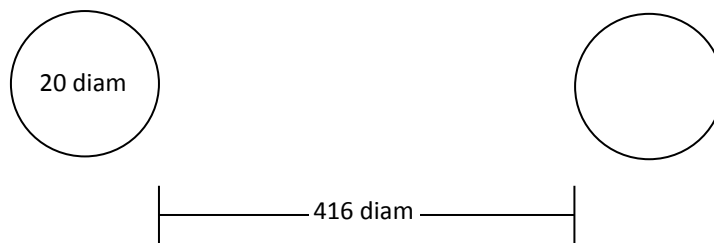

TANK LID SEALS

Product Code: Z185

Product Description: Manway Seal MSW470 Grey Silicone

NB: Can be made in any rubber compound to suit customer applications

- Food Grade Non Toxic Grey
- Odourless and Tasteless
- Long Lasting – Resistant to Mould and Dew
- Resistant to Moderate Chemicals, Fluids and Oils
- Will not rot
- Does not cause staining
- Resistant to Extreme Temperatures -50°C to $+200^{\circ}\text{C}$
- Does not support Fungoidal Growth, Mould or Bacteria
- Withstands Hot Water and Low Pressure Steam

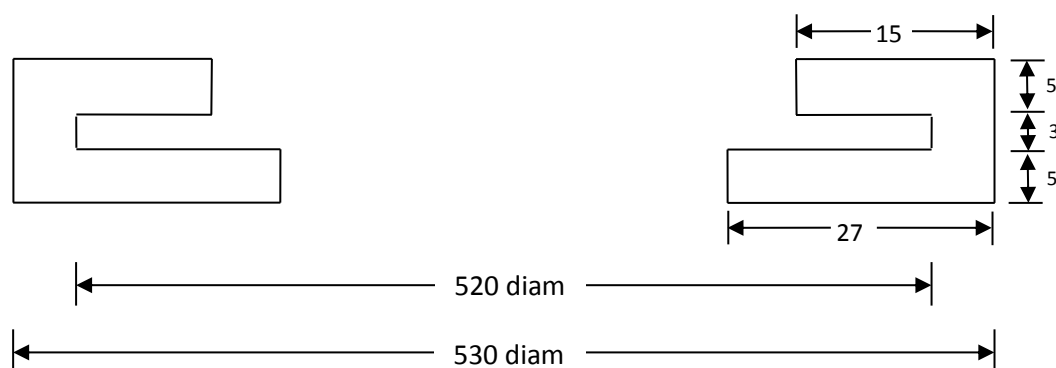

TANK LID SEALS

Product Code: Z186

Product Description: Manway Seal MWS420 Black Nitrile

NB: Can be made in any rubber compound to suit customer applications.

- Black Nitrile
- Resistant to Moderate Chemicals, Oils and Petrols
- Resistant to Temperature -20°C to +110°C
- Available in White, Black and Grey (made to order)

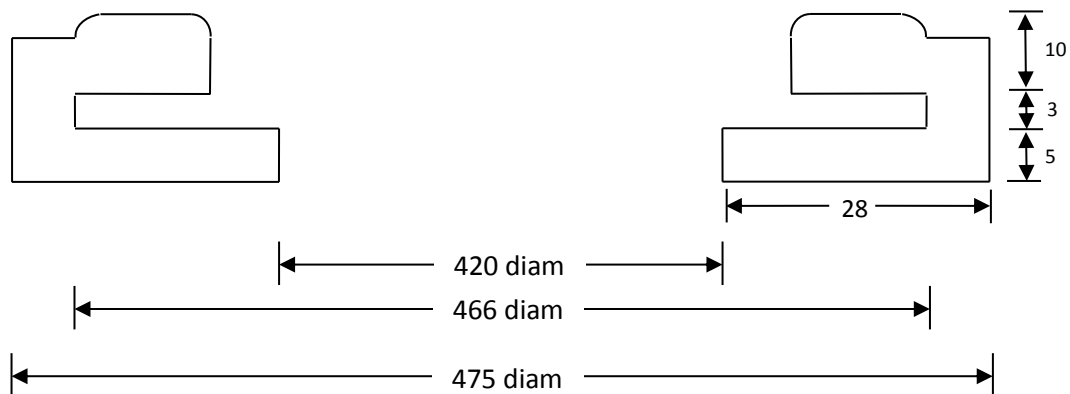

TANK LID SEALS

Product Code: Z188

Product Description: Manway Seal MWS360 Grey Silicone

NB: Can be made in any rubber compound to suit customer application.

- Food Grade Non Toxic Grey
- Odourless and Tasteless
- Long Lasting – Resistant to Oxidation, UV and Ozone
- Resistant to Mould and Dew
- Resistant to Moderate Chemicals, Fluids and Oils
- Will not rot
- Does not cause staining
- Resistant to Temperatures -50°C to $+200^{\circ}\text{C}$
- Does not support Fungoidal Growth, Mould or Bacteria
- Withstands Hot Water and Low Pressure Steam

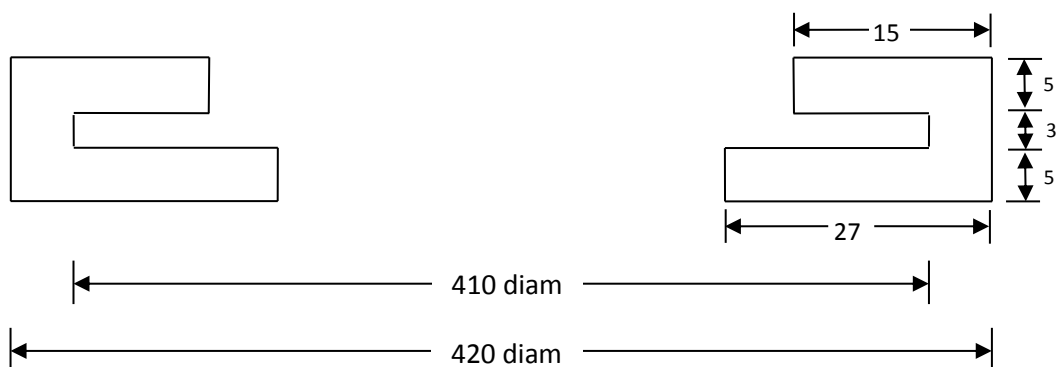

TANK LID SEALS

Product Code: Z189

Product Description: Manway Seal MWS400 Grey EPDM

- FDA Approved Reg 21 CFR 177.2600
- Long Lasting – Resistant to Oxidation, UV and Ozone
- Resistant to Mould and Dew
- Will not rot
- Resistant to Extreme Temperatures -50°C to +120°V
- Withstands Hot Water and Low Pressure Steam

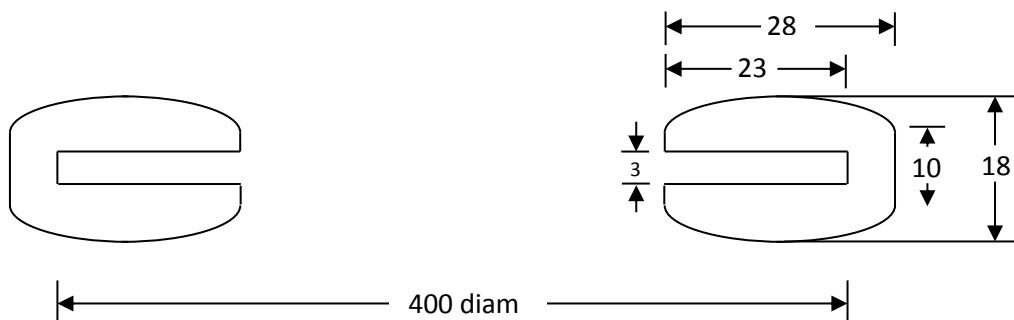

TANK LID SEALS

Product Code: Z189-1

Product Description: Manway Seal MWS2815 White Silicone

NB: Can be made in any other rubber compound to suit customer application.

- Food Grade Non Toxic White Silicone
- Odourless and Tasteless
- Long Lasting – Resistant to Oxidation, UV and Ozone
- Resistant to Mould and Dew
- Resistant to Moderate Chemicals, Fluids and Oils
- Will not rot
- Does not cause staining
- Resistant to Extreme Temperatures -50°C to +200°C
- Does not support Fungoidal Growth, Mould or Bacteria
- Withstands Hot Water and Low Pressure Steam

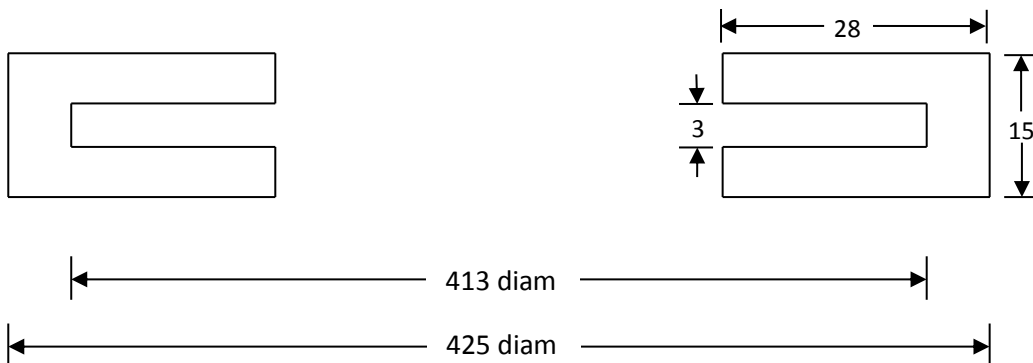

TANK LID SEALS

Product Code: Z206

Product Description: Manway Seal MWS440 Grey Silicone

NB: Can be made in any rubber compound to suit customer applications.

- Food Grade Non Toxic Grey
- Odourless and Tasteless
- Long lasting- Resistant to Oxidation, UV and Ozone
- Resistant to Mould and Dew
- Resistant to Moderate Chemicals, Fluids and Oils
- Will not Rot
- Do not cause staining
- Resistant to Extreme Temperatures -50°C to +200°C
- Does not support Fungoidal Growth, Mould or Bacteria
- Withstands Hot Water and Low Pressure Steam

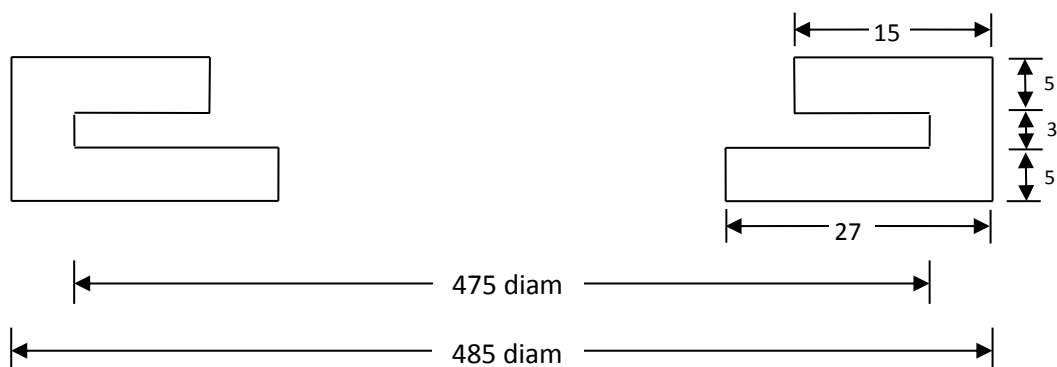

TANK LID SEALS

Product Code: Z208

Product Description: Manway Seal MWS420 White Silicone

NB: Can be made in any other rubber compound to suit customer application.

- Food Grade Non Toxic White
- Odourless and Tasteless
- Long Lasting – Resistant to Oxidation, UV and Ozone
- Resistant to Mould and Mildew
- Resistant to Moderate Chemicals, Fluids and Oils
- Will not rot
- Does not cause Staining
- Resistant to Extreme Temperatures -50°C to +200°C
- Does not Support Fungoidal Growth, Mould or Bacteria
- Withstands Hot Water and Low Pressure System

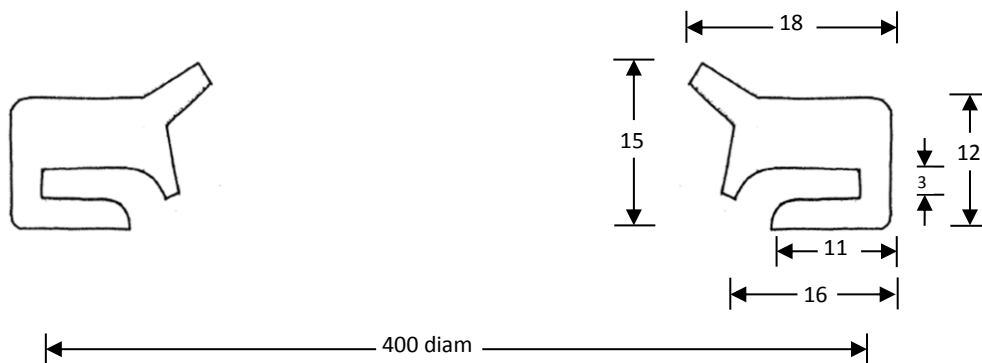

TANK LID SEALS

Product Code: Z209

Product Description: Manway Seal MWS510 white silicone

NB: Can be made in any other rubber compound to suit customer application.

- Food Grade Non Toxic White Silicone
- Odourless and Tasteless
- Long Lasting – Resistant to Oxidation, UV and Ozone
- Resistant to Mould and Mildew
- Resistant to Moderate Chemicals, Fluids and Oils
- Will not rot
- Does not cause Staining
- Resistant to Extreme Temperatures -50°C to +200°C
- Does not Support Fungoidal Growth, Mould or Bacteria
- Withstands Hot Water and Low Pressure System

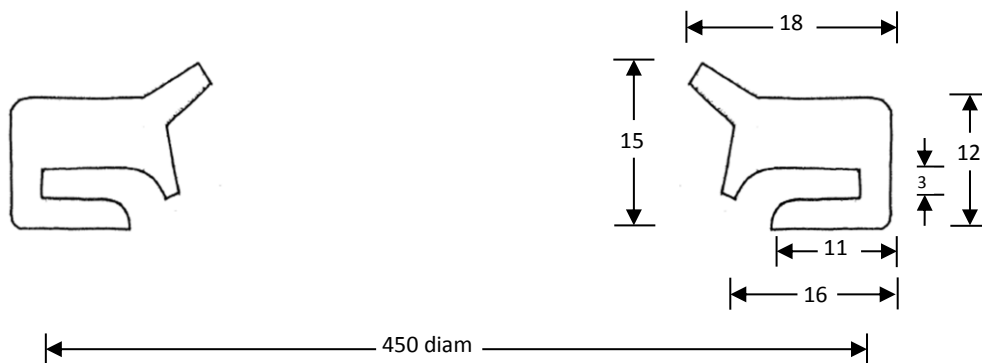

TANK LID SEALS

Product Code: Z210

Product Description: Manway Seal MWS440 Blue Silicone

NB: Can be made in any rubber compound to suit customer applications.

- Food Grade Non Toxic Blue
- Odourless and Tasteless
- Long lasting- Resistant to Oxidation, UV and Ozone
- Resistant to Mould and Dew
- Resistant to Moderate Chemicals, Fluids and Oils
- Will not Rot
- Do not cause staining
- Resistant to Extreme Temperatures -50°C to +200°C
- Does not support Fungoidal Growth, Mould or Bacteria
- Withstands Hot Water and Low Pressure Steam

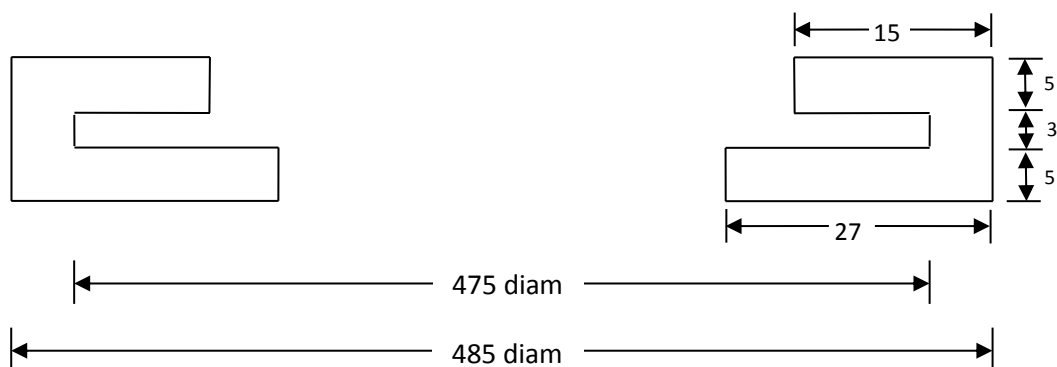

TANK LID SEALS

Product Code: Z213 White Silicone

NB: Can be made in any rubber compound to suit customer application.

Product Description: Tank Lid Seal White Silicone

- Food Grade Non Toxic White Silicone
- Odourless and Tasteless
- Long Lasting – Resistant to Oxidation, UV and Ozone
- Resistant to Mould and Dew
- Resistant to Moderate Chemicals, Fluids and Oils
- Will not rot
- Does not cause staining
- Resistant to Extreme Temperature -40°C to +200°C
- Does not support Fungoidal Growth, Mould or Bacteria
- Withstands Hot Water and Low Pressure Steam

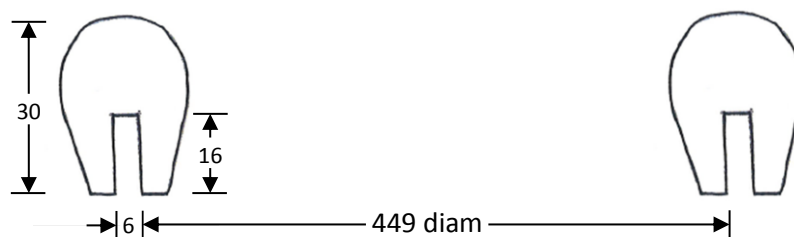

TANK LID SEALS

Product Code: Z220 White Silicone

NB: Can be made in any rubber compound to suit customer application.

- Food Grade Non Toxic White
- Odourless and Tasteless
- Long Lasting – Resistant to Oxidation, UV and Ozone
- Resistant to Mould and Mildew
- Resistant to Moderate Chemicals, Fluids and Oils
- Will not rot
- Does not cause staining
- Resistant to Extreme Temperatures -50°C to +200°C
- Does not Support Fungoidal Growth, Mould or Bacteria
- Withstands Hot Water and Low Pressure Steam

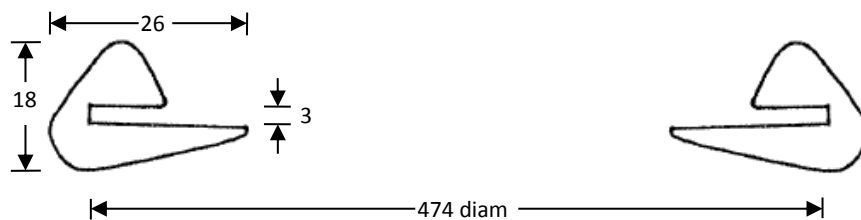

TANK LID SEALS

Product Code: Z221 Grey Nitrile

NB: Can be made in any rubber compound to suit customer applications.

- Grey Nitrile Rubber
- Temperature -30°C to +90°C
- 60 Duro Hardness

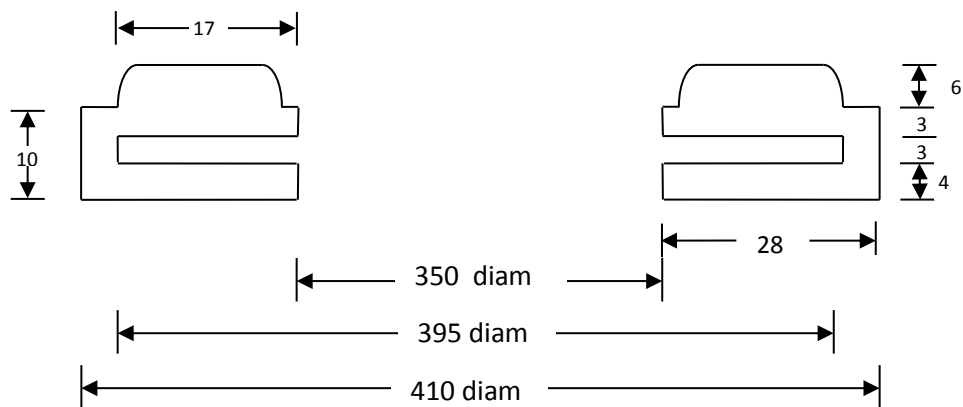

TANK LID SEALS

Product Code: Z223

Product Description: Lid Seal Silicone

NB: Can be made in any other rubber compound to suit customer application.

- Food Grade Non Toxic Translucent Silicone
- Odourless and Tasteless
- Long Lasting – Resistant to Oxidation, UV and Ozone
- Resistant to Mould and Dew
- Resistant to Moderate Chemicals, Fluids and Oils
- Will not rot
- Does not cause staining
- Resistant to Extreme Temperatures -50°C to $+200^{\circ}\text{C}$
- Does not support Fungoidal Growth, Mould or Bacteria
- Withstands Hot Water and Low Pressure Steam
- 40 duro hardness

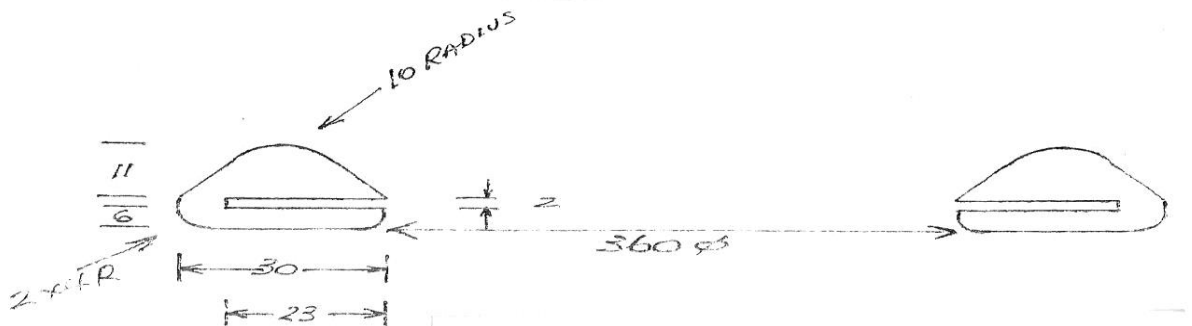

TANK LID SEALS

Product Code: Z226

Product Description: Lid Seal Silicone Blue Swap Door

NB: Can be made in any other rubber compound to suit customer application.

- Food Grade Non Toxic Blue Silicone
- Odourless and Tasteless
- Long Lasting – Resistant to Oxidation, UV and Ozone
- Resistant to Mould and Dew
- Resistant to Moderate Chemicals, Fluids and Oils
- Will not rot
- Does not cause staining
- Resistant to Extreme Temperatures -50°C to +200°C
- Does not support Fungoidal Growth, Mould or Bacteria
- Withstands Hot Water and Low Pressure Steam
- 40 duro hardness

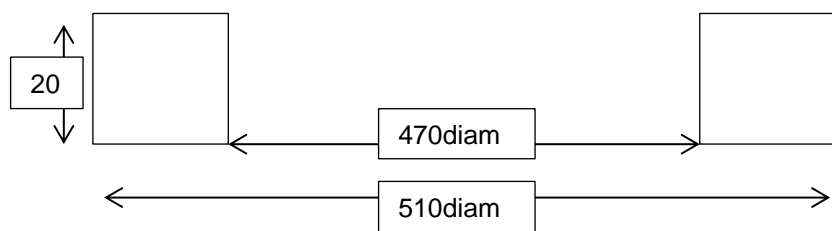

TANK LID SEALS

Product Code: Z227M

Product Description: Lid Clamp Seal Silicone Tapered

NB: Can be made in any other rubber compound to suit customer application.

- Food Grade Non Toxic 50 duro Blue Silicone
- Odourless and Tasteless
- Long Lasting – Resistant to Oxidation, UV and Ozone
- Resistant to Mould and Dew
- Resistant to Moderate Chemicals, Fluids and Oils
- Will not rot
- Does not cause staining
- Resistant to Extreme Temperatures -50°C to +200°C
- Does not support Fungoidal Growth, Mould or Bacteria
- Withstands Hot Water and Low Pressure Steam
- 50 duro hardness

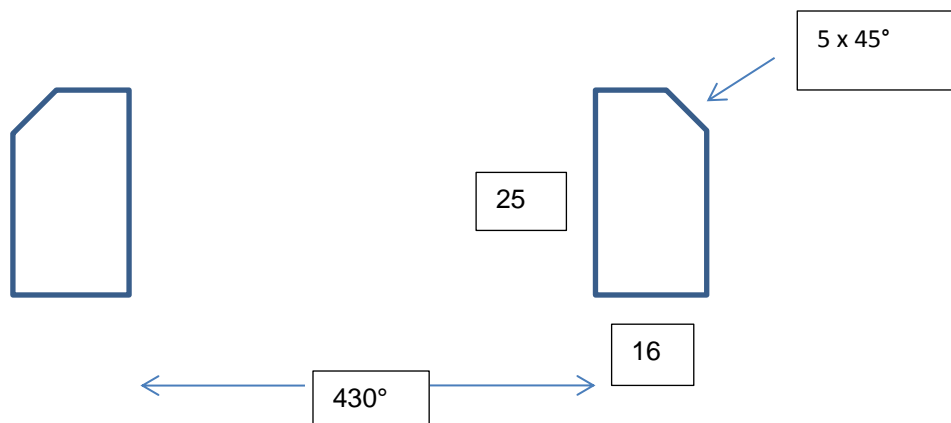

TANK LID SEALS

Product Code: Z227-600

Product Description: Lid Clamp Seal Silicone Tapered

NB: Can be made in any other rubber compound to suit customer application.

- Food Grade Non Toxic Blue Silicone 50 duro
- Odourless and Tasteless
- Long Lasting – Resistant to Oxidation, UV and Ozone
- Resistant to Mould and Dew
- Resistant to Moderate Chemicals, Fluids and Oils
- Will not rot
- Does not cause staining
- Resistant to Extreme Temperatures -50°C to +200°C
- Does not support Fungoidal Growth, Mould or Bacteria
- Withstands Hot Water and Low Pressure Steam
- 50 duro hardness

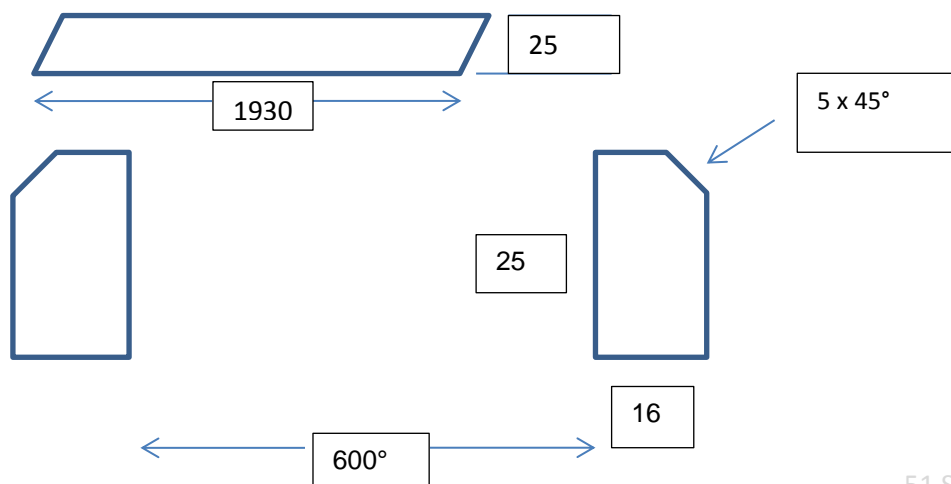

TANK LID SEALS

Product Code: ZT014N

Product Description: Manway Seal Black Nitrile

- Black Nitrile
- Resistant to Moderate Chemicals, Oils and Petrols
- Resistant to Temperature -20°C to +110°C

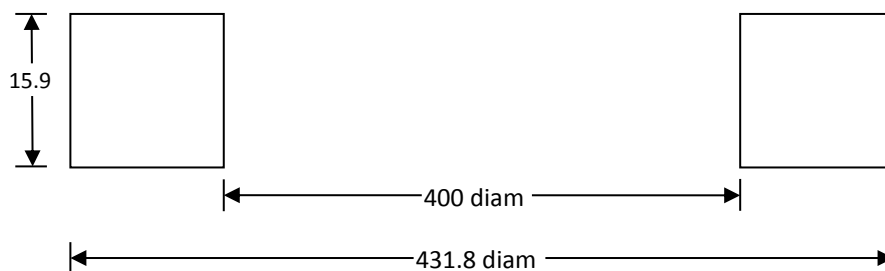

TANK LID SEALS

Product Code: ZT014V

Product Description: Manway Seal Black Viton

- Black Viton
- Resistant to Volatile Acids and Chemicals
- Resistant to Temperature -40°C to +200°C

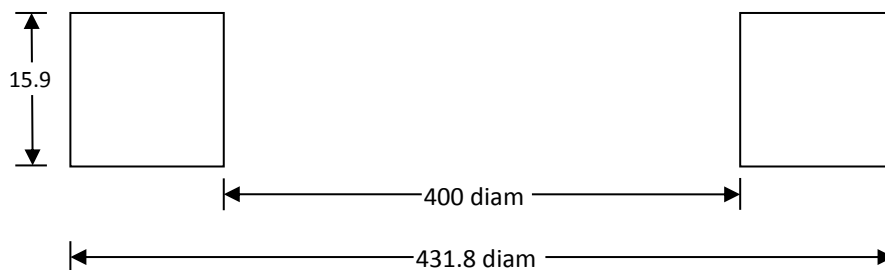

TANK LID SEALS

Product Code: ZT015N

Product Description: Manway Seal Black Nitrile

- Black Nitrile
- Resistant to Moderate Chemicals, Oils and Petrols
- Resistant to Temperature -20°C to +110°C

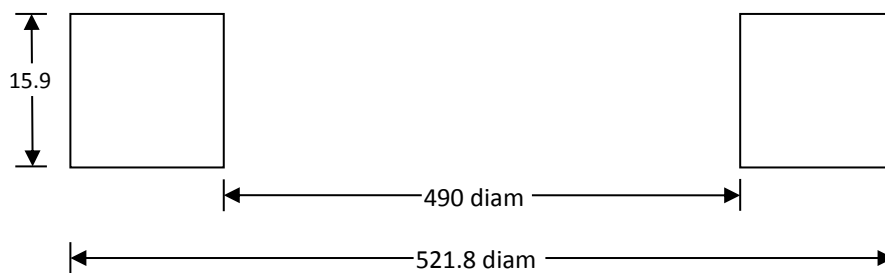

TANK LID SEALS

Product Code: ZT015V

Product Description: Manway Seal Black Viton

- Black Viton
- Resistant to Volatile Acids and Chemicals
- Resistant to Temperature -40°C to +200°C

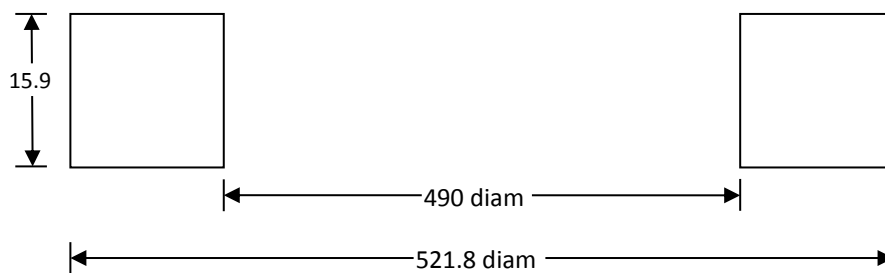

TANK LID SEALS

Product Code: ZZD00372

Product Description: Lid Seal Silicone

NB: Can be made in any other rubber compound to suit customer application.

- Food Grade Non Toxic Translucent Silicone
- Odourless and Tasteless
- Long Lasting – Resistant to Oxidation, UV and Ozone
- Resistant to Mould and Dew
- Resistant to Moderate Chemicals, Fluids and Oils
- Will not rot
- Does not cause staining
- Resistant to Extreme Temperatures -50°C to +200°C
- Does not support Fungoidal Growth, Mould or Bacteria
- Withstands Hot Water and Low Pressure Steam
- 40 duro hardness

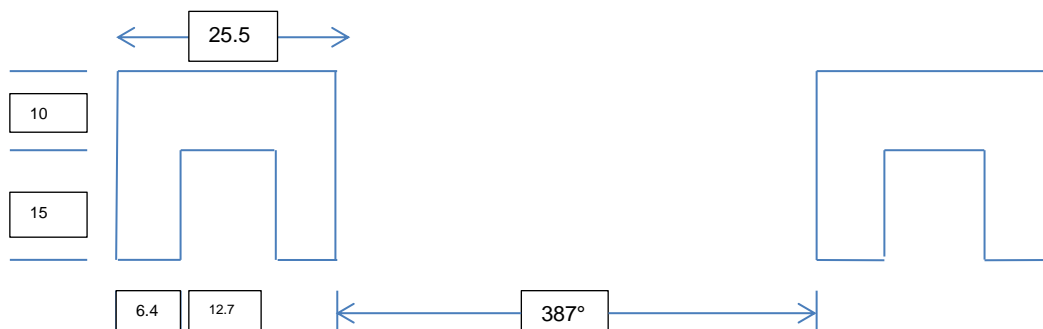

TANK LID SEALS

Product Code: ZZD00376

Product Description: Lid Seal Silicone

NB: Can be made in any other rubber compound to suit customer application.

- Food Grade Non Toxic Translucent Silicone
- Odourless and Tasteless
- Long Lasting – Resistant to Oxidation, UV and Ozone
- Resistant to Mould and Dew
- Resistant to Moderate Chemicals, Fluids and Oils
- Will not rot
- Does not cause staining
- Resistant to Extreme Temperatures -50°C to +200°C
- Does not support Fungoidal Growth, Mould or Bacteria
- Withstands Hot Water and Low Pressure Steam
- 40 duro

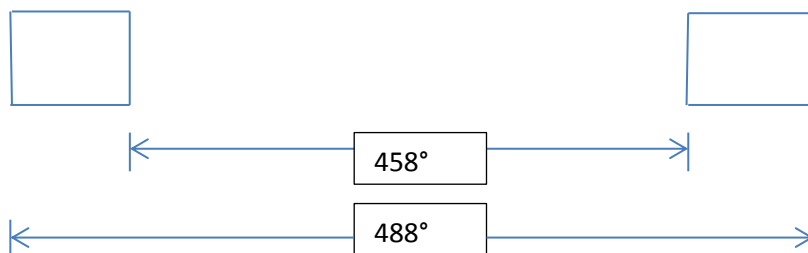

TANK LID SEALS

Product Code: ZZE00015-1

Product Description: Manway Hatch Seal CRE1308

- Premium Grade High Acrylonitrile Rubber
- Hardness: 45 Duro +/- 5
- Excellent Resistance to Pterol, Oil and Solvent including Modern Day Fuels
- Resistant to Temperatures -20°C to +110°C
- Available in Black Only
- A High Grade Rubber Hatch Seal Used in the Transportation of Fuels, Oils etc

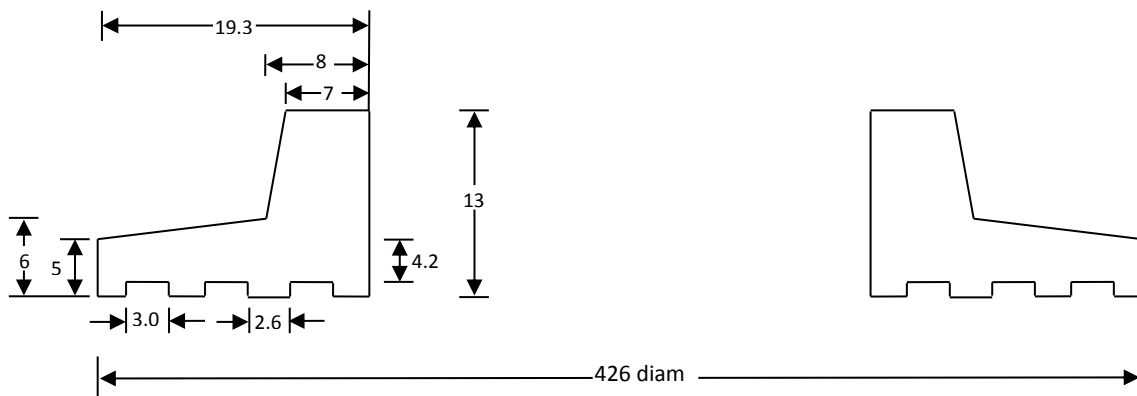

TANK LID SEALS

Product Code: ZZL00019

Product Description: Lid Seal Silicone

NB: Can be made in any other rubber compound to suit customer application.

- Food Grade Non Toxic White Silicone
- Odourless and Tasteless
- Long Lasting – Resistant to Oxidation, UV and Ozone
- Resistant to Mould and Dew
- Resistant to Moderate Chemicals, Fluids and Oils
- Will not rot
- Does not cause staining
- Resistant to Extreme Temperatures -50°C to $+200^{\circ}\text{C}$
- Does not support Fungoidal Growth, Mould or Bacteria
- Withstands Hot Water and Low Pressure Steam
- 50 duro hardness

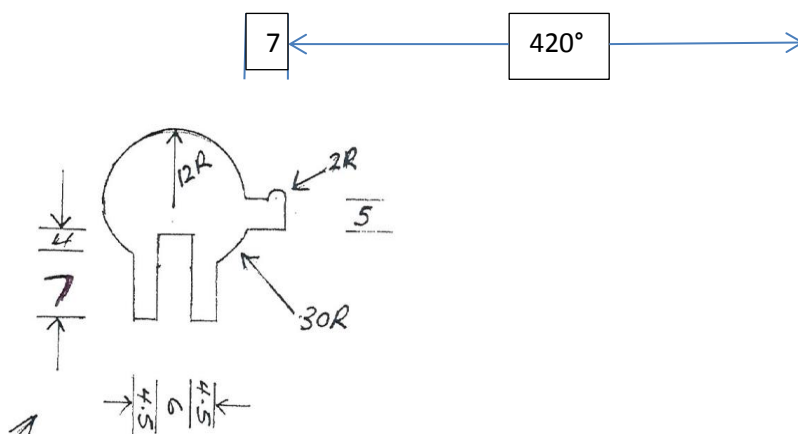

TANK LID SEALS

Product Code: ZZM00006

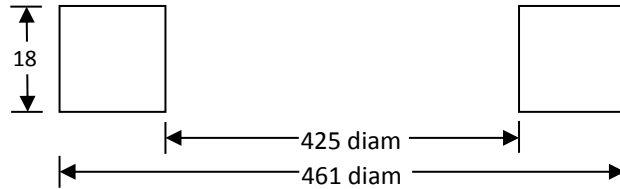

Product Code: ZZM00007

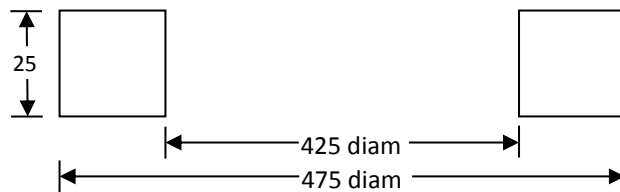

Product Code: ZZM00008

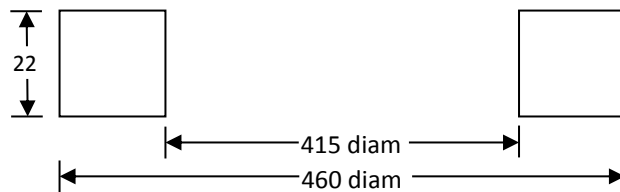

Product Code: ZZM00009

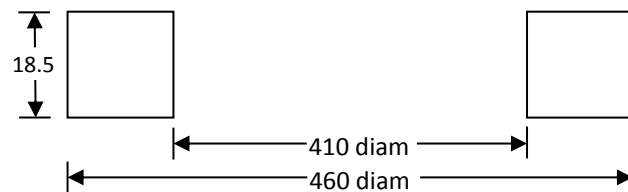

Product Code: ZZM00010

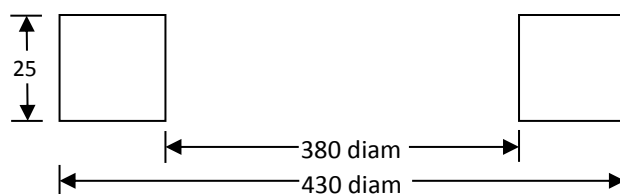

- CAN BE SUPPLIED IN ANY COMPOUND

TANK LID SEALS

Product Code: ZZT00158

Product Description: Mash Door Seal

NB: Can be made in any other rubber compound to suit customer application.

- Food Grade Non Toxic White Silicone
- Odourless and Tasteless
- Long Lasting – Resistant to Oxidation, UV and Ozone
- Resistant to Mould and Dew
- Resistant to Moderate Chemicals, Fluids and Oils
- Will not rot
- Does not cause staining
- Resistant to Extreme Temperatures -50°C to +200°C
- Does not support Fungoidal Growth, Mould or Bacteria
- Withstands Hot Water and Low Pressure Steam
- 40 duro hardness

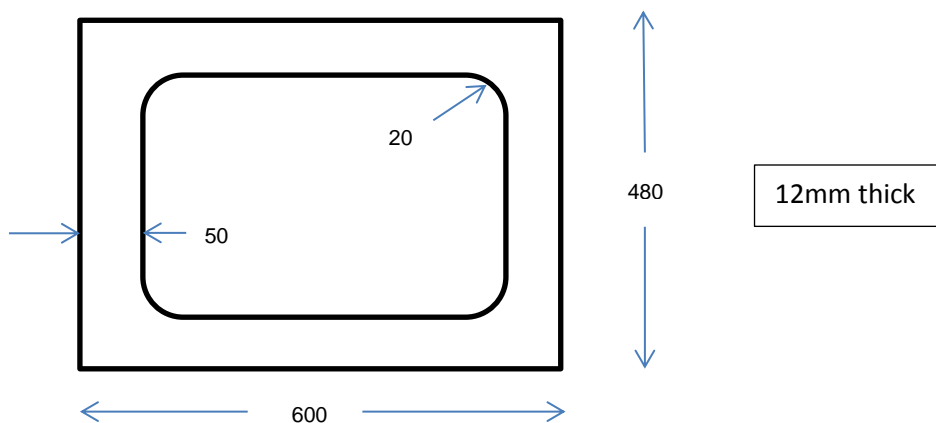

TANK LID SEALS

EXTRUSIONS

Product Code: Z177

Material: White Silicone FDA
50 Duro

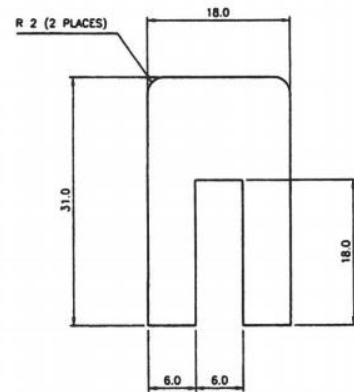

Product Code: Z177-1

Material: White Silicone FDA
50 Duro

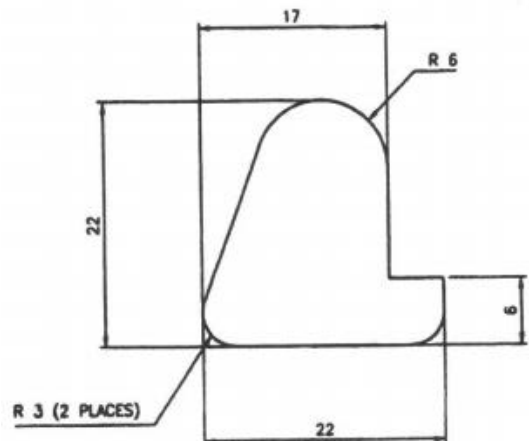

Product Code: Z211

Material: White Silicone
50 Duro

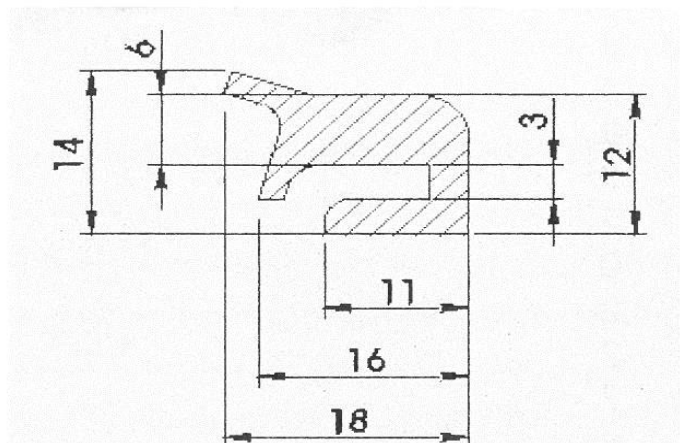

TANK LID SEALS

EXTRUSIONS

Product Code: Z212

Material: White Silicone
50 Duro

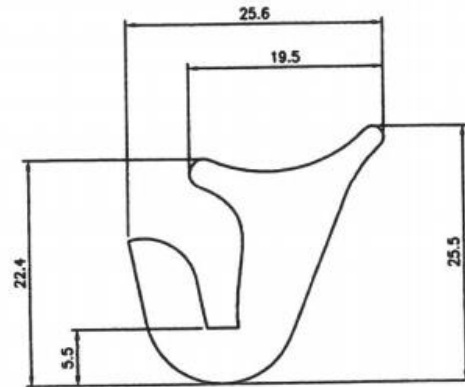

Product Code: Z225

Material: Grey Silicone
50 Duro

